

Murtadha S. SatchetCivil Eng. Department
University of Thi-Qar
Nasiriyah 64001, Iraq
murtadha-s@utq.edu.iqReceived on: 11/01/2018
Accepted on: 25/06/2018
Published online: 25/11/2018

Geomatics Techniques to Evaluate Bus Service Coverage A Case Study on Nasiriyah, Iraq

Abstract- In this paper, geomatics techniques were used to collect, build, and analyze a geo-database of the bus transport network. Spatial identification of bus routes and bus stops using GPS was performed using GIS to link and analyze the necessary metadata with the available spatial data. The criteria used to assess bus service coverage were as follows: the spatial coverage in terms of the walking distance to the transport service, the adequacy of the transport network length, and extent of supply availability of the bus transport system. The results revealed that the population “living in 47% of the city’s urban area” could arrive at a transport service within a period of less than 5 minutes (in other words, a walking distance of less than 400 m), which is the typical time to arrival. Furthermore, the study concluded that the current length of the transport network is sufficient to provide typical spatial coverage for the city’s entire urban area if redistributed.

Keywords- Bus Transport; Service Coverage; Spatial Analysis; Geomatics; GIS

How to cite this article: M. S. Satchet, “Geomatics Techniques to Evaluate Bus Service Coverage, a Case Study on Nasiriyah, Iraq,” *Engineering and Technology Journal*, Vol. 36, Part A, No. 11, pp. 1148-1157, 2018.

Abbreviations and Acronyms

CBD: Central Business District
GIS: Geographical Information System
GPS: Global Positioning System
LB: Long Bus
LBDD: Large Bus Double Decker
LOS: Level of Service
SB: Small Bus
SCPT: State Company for Private Transport
TCQSM: Transport Capacity and Quality of Service Manual

1. Introduction

In modern times, transportation is an important activity practiced by human beings in cities to achieve constant communication between home, work centers, educational institutions, shopping and other entertainment establishments. The efficiency of the transportation system increases with the expansion of cities, increase in various activities, and well-planned land use. The development of the transportation system has become one of the basic requirements for the success of comprehensive development plans and achievement of economic and social progress at various levels. Therefore, organizing the transport system and providing the best service to travelers is prioritized by countries, institutions, and the business sector. One feature of an efficient transport system within cities is that it provides typical spatial coverage for the entire city and enables reaching destinations in the shortest time. As such, it becomes the ideal transport option for passengers, rather than individual vehicles

(personal car, taxi), which increase traffic, air pollution, noise, and energy consumption [1-3]. In the literature, evaluation of accessibility to the transport service depends on three primary components: trip coverage, spatial coverage, and temporal coverage [4]. Trip coverage means that passengers consider public transport as accessible when it is available to and from their trip origin and destination. Spatial coverage refers to transport accessibility if the service is available within reasonable physical proximity to passengers’ homes and destinations. According to temporal coverage, a service is accessible when it is available at the times when one wants to travel. Several studies indicate that the best methodology for measuring the quantity and quality of services should incorporate these three important accessibility measures. However, in many cases, it is not possible to consider all these aspects. Some existing measures of transport accessibility consider both spatial and temporal coverage [1,5]. The Transport Capacity and Quality of Service Manual (TCQSM) identifies spatial coverage according to the presence or lack of transport services within a walking distance of 400 m (0.25 mi) or less to bus stops [6]. Generally, an increase in the number of daily trips by the Iraqi population, especially those living in Nasiriyah, has become common as a result of what Iraq has witnessed during the past years—namely, an increasing population, openness to the outside world, improved income level, and the possibility of much of the population owning modern private transport. These aspects are positively reflected in the increased number of daily trips of residents

within the city, and thus increased pressure on the road network. For example, the Abdul Rahman study conducted in 2015 showed that 51% of daily trips within Nasiriyah City were by private car, and only 27% by bus [7,8]. The bus transport service in Nasiriyah is primitive, and has not expanded to address the population's increased demand for daily trips. Consequently, the bus transport network is unable to provide typical spatial coverage of the whole city, as discussed in this paper. Spatial coverage is a measure of the area within walking distance to the transport service. It is solely an area measure, and does not provide a

complete assessment of transport system availability [1]. The maximum distance that people will walk to a transport service varies depending on the situation. Figure 1 provides the results of several studies on walking distances to transport in North American cities. Although there is some variation between cities and income groups among the studies represented in the Figure, most passengers (75 to 80% on average) walk 400 m (0.25 mi) or less to bus stops, at an average walking speed of 5 km/h (3 mi/h). This is equivalent to a maximum walking time of 5 min [6,9,10].

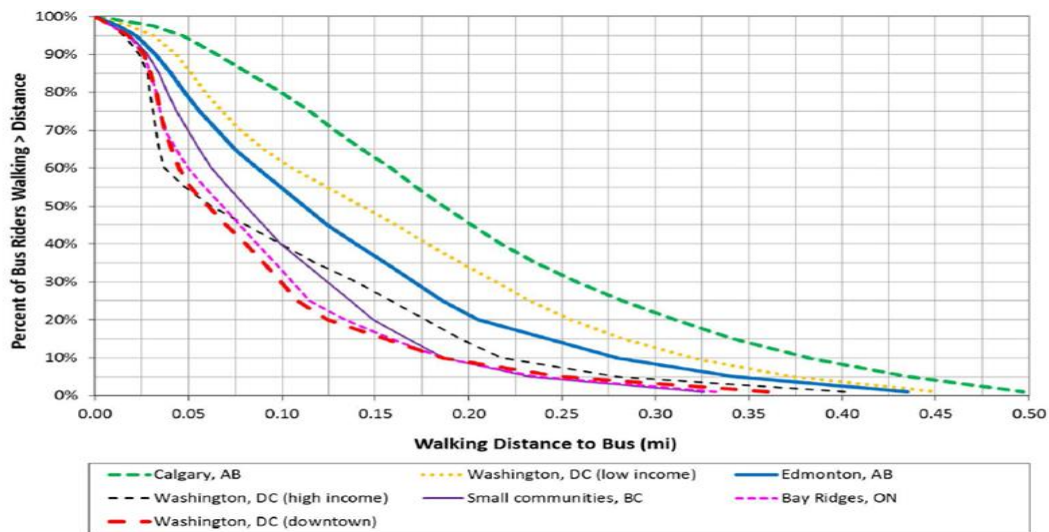

Figure 1: Walking distance to bus stops (Source: TCQSM, Report 165, Ch. 4, P.18)

Geomatics is a scientific term given to the science and techniques that regulate the collection, presentation, management, and use of spatial data in digital form. There are many different types of Geomatics, each with a unique purpose. Some include land surveying, remote sensing, GPS, GIS, and photogrammetry. GIS provides a wide space to accommodate and analyze spatial data patterns to contribute to effective planning and decision-making [11]. The use of GIS techniques is now more common in transport research and modeling [12]. GIS was used in this study to manage and analyze spatial data and GPS data to determine the typical spatial coverage of the bus transport service within the study area for the purpose of evaluation. Based on literature review, no geo-database is available for the Nasiriyah transport network. Therefore, this is a pioneering study of this region. The aims of this study are summarized as follows:

1. To establish the first geo-database for the Nasiriyah bus transport network, which can be employed in this study and other research in the future.

2. To determine the level of spatial coverage of the transport service depending on the walking distance to bus stops.
3. To conduct a performance evaluation of the bus network length and extent of supply availability of the transport system.

2. Study Area

The city of Nasiriyah was selected as the study area. It is located in the southeast of Iraq on the Euphrates River with latitudes $31^{\circ} 02' N$ and longitudes $46^{\circ} 14' E$. Nasiriyah is the administrative center of the province of Thi-Qar and houses the fourth largest population in the country after the provinces of Baghdad, Basra, and Nineveh. The Euphrates River divides the city into the northern and southern parts. The northern part is Al-Jazerah, the largest part of the city, which includes the CBD and the master garage, which houses the entire city's buses. The southern part is Al-Shamyah, as shown in Figure 2. The population of Nasiriyah City is 455,700 according to the latest census in 2010; the population is distributed

among 57 residential districts, of which 25 are in Al-Shamyah and 32 in Al-Jazerah. The bus transportation system in the city of Nasiriyah is private, not governmental. A government agency sponsors the operation of private transport within the city. Known as the State Company for Private Transport (SCPT), it belongs to the Iraqi Ministry of Transportation. The company provides a unified garage for the assembly of the 20 transport lines near the CBD, which is considered the main

destination for most of the city's population, and is responsible for tasks such as issuing licenses for buses and fixing the price of tickets. There is no pre-planning for spatial distribution of the bus routes within the city. Until now, the issue of determining routes was subject to the demand of passengers and opinions of bus owners based on financial profit. Therefore, some city districts have numerous bus routes, while others do not.

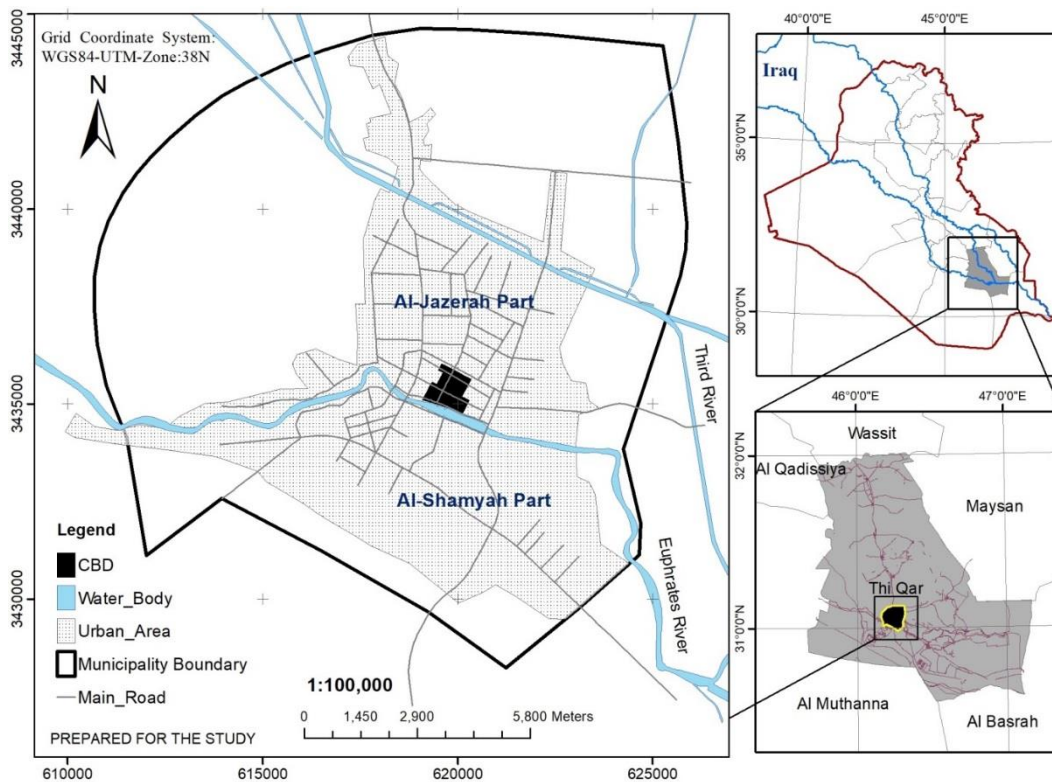

Figure 2: Study Area (Nasiriyah city)

3. Methodology

3.1. Determination of Spatial Coverage

Based on the criterion of walking distance to the transport system, this study classified the level of spatial coverage provided by the bus stops in the study area into four bands, as detailed in Table 1. There are two methods to spatially determine these bands for developing future treatments for low-coverage areas—namely, the GIS method and the

manual (graphical) method [4,13]. In this paper, the GIS method was used, as it requires less effort to calculate the spatial coverage area than the manual method. The manual method requires building an analytical model using the spatial analysis tools of the ArcGIS-10 software considering previously collected data (bus routes, bus stops, CBD location, limits of the urban area, criterion of walking distance), as shown in Figure 3.

Table 1: Proposed spatial coverage bands provided by the bus stops

Spatial Coverage Level / Band	Walking Distance (m.)	Walking Time (min.)	Band Color
TYPICAL	0 – 400	0-5	Green
MID	400 – 800	5-10	Yellow
LOW	800 – 1200	10-15	Red
FAR	> 1200	> 15	Grey

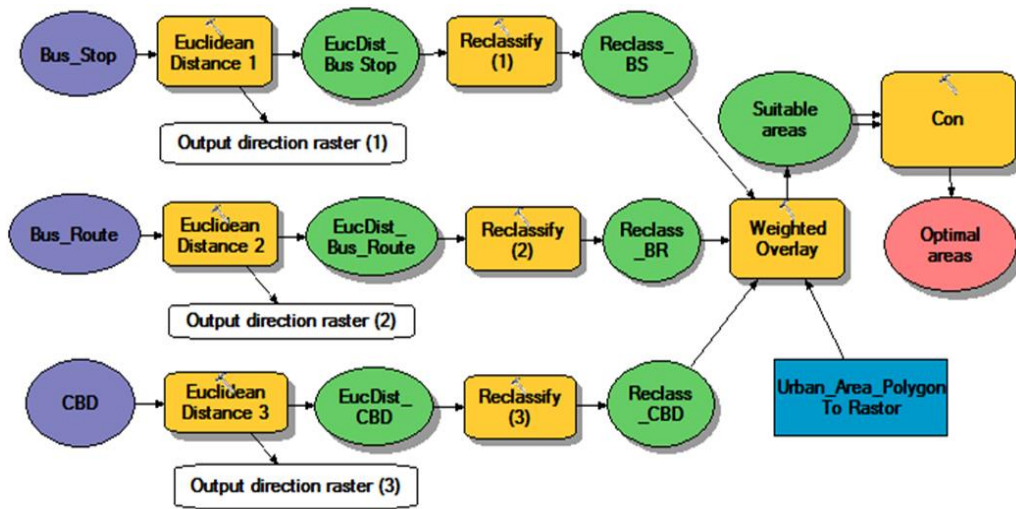

Figure 3: The GIS analytical model algorithm

The methodology used in the model is simple and based on two relationships. The first is an inverse relationship between the spatial coverage and location of the bus stops, such that an increase in passengers' walking distance to reach the bus stop decreases the level of spatial coverage. The second is the positive relationship between the CBD location of the city and the population's need to use the bus transport service. When the distance to the CBD is shorter, the population's need to use the bus transport service decreases.

II. Performance of the bus network length

Each distance of 1 km along the bus transport network length should meet the transport needs of the population over 1 km² of the city's urban area [6,14]. Using the data and previous analysis in this study, the performance of the transport network length can be assessed based on the following relation:

$$\text{Performance of the bus network length} = A/B \quad (1)$$

Where:

- A: Total length of Bus Transport Network (per km).
- B: Area of urban limits.

Table 2 specifies the level of service with regarding to the result of performance of the bus network length.

Table 2: Level of service for transport network length.

LOS	Performance of the bus network length
1	≥ 1
2	0.7 - 1.0
3	0.3 - 0.7
4	< 0.3

III. Extent of supply availability of the transport system

When evaluating the coverage of the bus service in a city, it is necessary to know the availability of transport supplies along the routes of the transport network. As per the urban bus toolkit, the number of buses required is typically between 0.6 and 1.2/1,000 population [6,14]. To determine the extent of supply availability, the following relationship was employed:

$$\begin{aligned} \text{Extent of supply availability/1,000 Population} \\ = A / \left(\frac{B}{1000} \right) \end{aligned} \quad (2)$$

Where:

- A: Total Number of Buses in the city transport network
- B: Total population of the city (in the study year)

Table 3 specifies the level of service with regarding to the result of extent of supply availability of transport system.

Table 3: Level of service for extent of supply availability of the transport system.

LOS	Extent of supply availability of transport system
1	≥ 0.6
2	0.4 - 0.6
3	0.2 - 0.4
4	< 0.2

The population of Nasiriyah city was 455,700 people according to the latest census in 2010. To determine the approximate number of the population for the study year of 2017, the following formula for the population growth rate was applied:

$$P_T = P_o (1 + r)^n \tag{3}$$

Where:

P_T: The population's approximate number in the study year (2017)

P_o: The population's actual number in the latest census year (2010)

r: The population growth rate

n: Number of years between P_T and P_o

4. Data Collection and Management

The SCPT government agency, which sponsors the operation of private transport in the region of study, does not have a modern digital map of the

bus routes. To prepare this map, cooperation with the Nasiriyah municipality directorate was entered into to obtain reliable data that could be dealt with using GIS software. Satellite image specifications as a raster of the collected GIS data are shown in Table (4), while the city master plan as vector data contains the street network layer, residential district limits, and current and future land use layers.



Table 4: Satellite image specifications for study area (Source: ASTRIUM Company)

Item	Description	Image Sample
Image Area	Nasiriyah /Iraq	
Image dimensions	12.1 km x 15.8 km = 191.18 km ²	
Production	ASTRIUM Services	
Processing level	ORTHO	
Number of bands	4 (B0,B1,B2,B3)	
Spatial resolution	50 cm	
File Format	TIF	
Acquisition date	2013-08-22 07:47:44.9	
Coordinate System	Projected, EPSG:32638	
Corners coordinates	Lower Left E:614100 , N:3429500 Upper Right E:625200 , N:3444800	

The other type of data collected in collaboration with the SCPT is metadata, which includes the names of registered bus routes, the number of buses per route, bus capacity, number of daily trips per bus, and other information summarized in Tables (5) and (6). In the field, spatial tracking of

bus routes with identified bus stops was performed using a single-frequency GPS, with the device installed on a bus to record the route of the trip from and to the transport garage. The same procedure was repeated for the other routes.

Table 5: Data for buses operating within the transport system of the study area

Route No.	Bus Type	No. of Passenger Seats	Bus Trips		Bus Photo
			At Workday	At Holyday	
J.01	Minibus-KIA	11	4	3	 Minibus-MERCEDES  Minibus-RAF
J.02	Minibus-MERCEDES	18	4	3	
J.03	Minibus-MERCEDES	18	6	4	
J.04	Minibus-MERCEDES	18	4	3	
J.05	Minibus-RAF	11	4	3	
J.06	Minibus-MERCEDES	18	4	3	
J.07	Minibus-MERCEDES	18	4	3	



J.08	Minibus-RAF	11	6	3	 Minibus-KIA	
J.09	Minibus-KIA	11	6	4		
J.10	Minibus-KIA	11	5	3		
J.11	Minibus-MERCEDES	18	4	3		
J.12	Minibus-RAF	18	4	3		
S.01	Minibus-MERCEDES	18	4	2		 TAXI BUS
S.02	Minibus-KIA	11	4	2		
S.03	Minibus-MERCEDES	18	4	2		
S.04	Minibus-KIA	11	4	2		
S.05	Minibus-MERCEDES	18	4	2		
S.06	Minibus-KIA	11	4	2		
S.07	TAXI BUS	4	4	2		
S.08	TAXI BUS	4	4	2		

Table 6: Data for the bus routes of the transport system of the study area

Route No.	Route Destination		Route length / Km Back and forth	Total No. of Buses	Bus Trips / Day	
	From	To			At Workday	At Holyday
J.01	Al-Aramil	CBD	5.26	12	48	36
J.02	Salehya	CBD	6.06	7	28	21
J.03	Ur	CBD	5.52	13	78	52
J.04	Sumer	CBD	7.32	7	28	21
J.05	Tadhyah	CBD	8.92	14	56	42
J.06	Shuhada-on street	CBD	8.67	25	100	75
J.07	Shuhada-dakhel	CBD	8.99	25	100	75
J.08	Fidaa	CBD	7.15	22	132	66
J.09	Exterior Garage	CBD	9.46	25	150	100
J.10	Sader City	CBD	10.85	35	175	105
J.11	Arido	CBD	11.39	70	280	210
J.12	Shufah	CBD	20.11	30	120	90
S.01	Sekak	CBD	8.98	7	28	14
S.02	Thawra	CBD	9.35	15	60	30
S.03	Emarat	CBD	9.93	22	88	44
S.04	Mansuryah	CBD	10.65	30	120	60
S.05	Shumukh	CBD	10.96	7	28	14
S.06	Eskan	CBD	17.20	40	160	80
S.07	Sayh	CBD	22.53	8	32	16
S.08	Qaida	CBD	34.57	8	32	16
Σ			233.88	422	1843	1167

5. Results and Discussion

ArcGIS version 10.2 (© ESRI), a prominent GIS software, was used to manage and analyze the data. Raster and vector data were input to build the GIS model and create new layers for bus routes and bus stops based on GPS spatial tracking then Topology was used to ensure data quality of the spatial relationships and to aid in data compilation.

The input spatial layers with metadata included the route number, route destination from/to, route length/km, total no. of buses, bus type, no. of passenger seats/bus, bus trips/day, no. of passengers/day. After completing the steps above, the geo-database for the Nasiriyah transport network was ready, as shown in Figure (4). The database is flexible and can be updated, enabling many analyses and the production of maps.

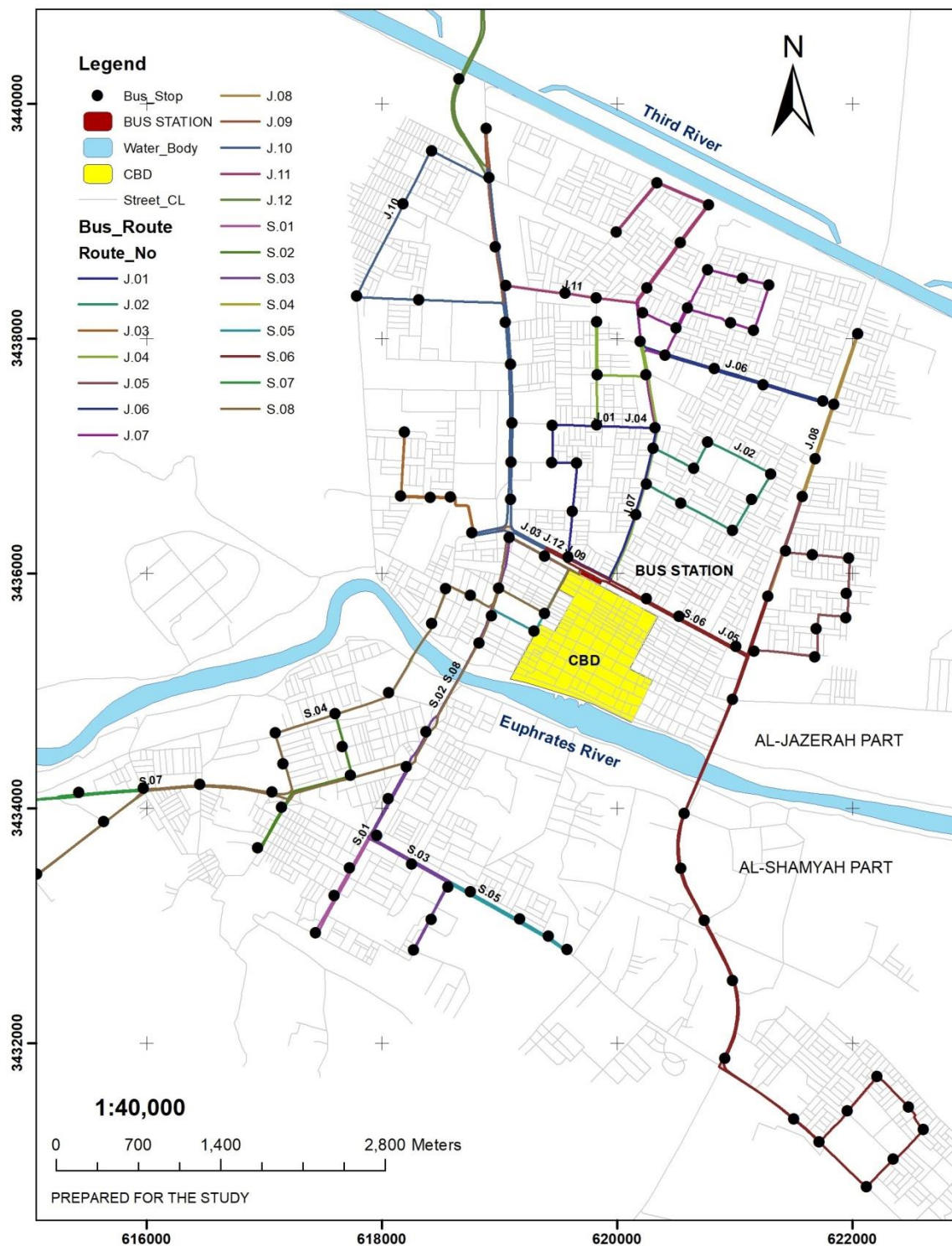

Figure 4: Map of the bus transport network in the study area (Nasiriyah city)

Figure (5- A and B) shows the buffer representation for the two relations mentioned in methodology of determination of spatial coverage (a buffer in GIS is a zone around a map feature

measured in units of distance or time). By intersecting the two relations, the GIS model classified the urbanized area into four bands of spatial coverage, as shown in Figure (6).

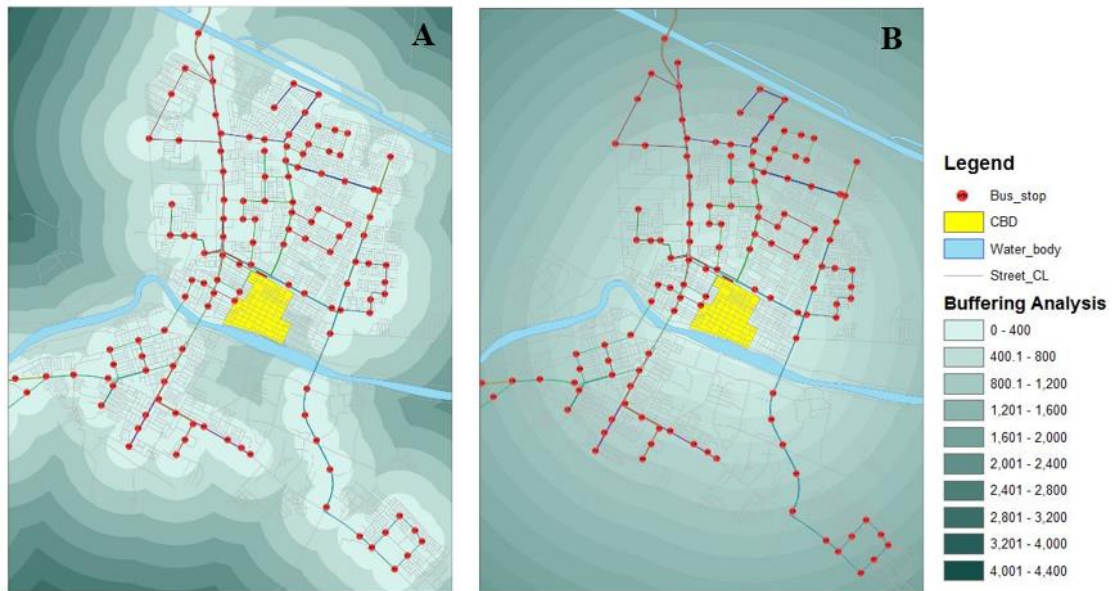

Figure 5: A- Buffer analysis for the inverse relationship between the level of spatial coverage and bus stops, B- Buffer analysis for the positive relationship between the CBD location and population's need to use the bus transport service.



Figure 6: Results of the level of spatial coverage for the urban area in Nasiriyah city

Inference: The results for determining spatial coverage indicated that 47% of the city's urban area has typical coverage, meaning that inhabitants walk less than 400 m to a bus stop. In addition, in

27% of the city urban area, inhabitants must walk between 400 to 800 m to arrive at a bus stop, referred to as MID spatial coverage. The rest of the percentages and areas are presented in Figure (7).

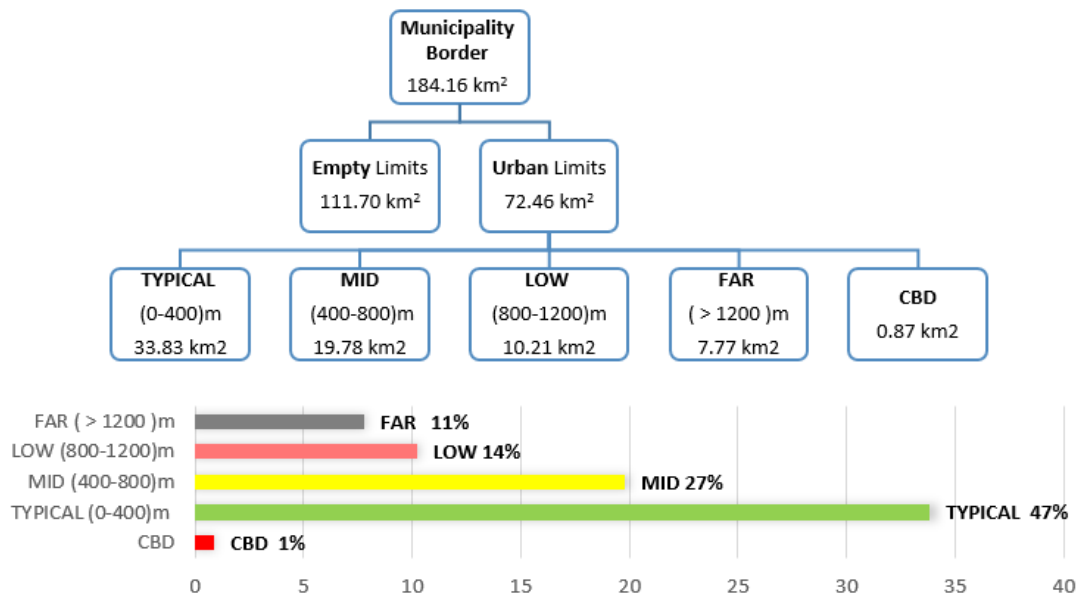

Figure 7: Percentages of the level of spatial coverage

In the study area, A = 88.35 km (from origin to destination, without bus route Nos. S.07 and S.08, because they are semi-external routes), and B = 72.46 km². Therefore:

Performance of bus network length = A/B = 1.22

LOS = 1

This means that the level of service for the length of the transport network is excellent, but the lack of pre-planning of the expansion of bus routes within the city led to a concentration of typical spatial coverage in only 47% of the urban area. Buses were classified according to the capacity of

passenger seats into small bus (SB), large bus (LB), and large bus double decker (LBDD) [15], as shown in Table (7). In the study area, the actual number of buses on the transport network was 422 of different capacities: 213 buses had 18 passenger seats, and the rest had 11 passenger seats or less. To consolidate the computations, the total number of passenger seats in all buses was calculated (6,021 seats), and then divided according to the highest number of bus seats for the SB type to calculate the number of buses in service (172 buses).

Table 7: Bus type according to the capacity of passenger seats.

Code	Name	Description
SB	Small Bus	12 -35 seated passengers (excluding driver)
LB	Large Bus	36 or more seated passengers (excluding driver) including both rigid 2 and 3 axle and articulated buses.
LBDD	Large Bus Double Decker	80 or more seated passengers (excluding driver) including both rigid 2 and 3 axle and Double Decker buses.

By adopting the expected population growth rate (2.7%) for the years after the previous census of Iraq and especially Nasiriyah city (Source: Census of the population, buildings, and families in 2010: The Central Bureau of Statistics–Ministry of Planning):
 $P_{2017} = 455,700 (1 + 0.027)^7 = 549,126$

Extent of supply availability/1,000 Population
 $= 172 / \left(\frac{549,126}{1000} \right) = 0.31$

Therefore **LOS = 3**

If the extent of supply availability of the transport system is calculated for the city's urban area that has a typical level of spatial coverage, where the

area of this part in addition to the CBD is 48% of the total area of the urban area:

Extent of supply availability
 (for CBD and TYPICAL areas) = $\frac{0.31}{0.48} = 0.65$

Therefore **LOS = 1**

6. Conclusions

1. The beginning of the establishment and expansion of the spatial distribution of the bus transport network in the study area was not pre-planned, but was subject to the demand of passengers and opinions of bus owners to ensure financial profit. This resulted in the concentration of the availability of transport routes in densely

populated areas located in the heart of the city, while newly established and low-population areas were neglected.

2. The population “living in 47% of the city's urban area” can arrive at a transport service within a period of less than 5 minutes (in other words, by walking less than 400 m), which is the typical time to arrival, while the population in other parts of the urban area takes (>5–20) minutes to reach the bus service.

3. If the bus routes of the city transport network are redistributed, the current route length can provide typical spatial coverage for the city's entire urban area.

4. The number of buses operating in the current transport network is sufficient to ensure the availability of transport supplies along the network route. However, if the plan is to distribute transport network routes to provide typical spatial coverage of the city's entire urban area, the bus fleet will need to increase by 85% from its current number.

Acknowledgments

The author extends special thanks Thi-Qar University for providing the necessary instruments and software to complete this study. In addition, the following Iraqi government offices are gratefully acknowledged for their data support:

- State Company for Private Transport (SCPT), Ministry of Transportation
- Directorate of Nasiriyah Municipality–Ministry of Municipalities
- The Central Bureau of Statistics–Ministry of Planning

References

- [1] L. Ebolia, C. Forcinitia, and G. Mazzullaa, “Service coverage factors affecting bus transit system availability,” University of Calabria, via Pietro Bucci, Rende 87036, Italy, *Procedia - Social and Behavioral Sciences* 111– 984 – 993, 2014.
- [2] K. Jumsan, J. Misun, K. Jongmin, and K. Seongyoung, “Determination of a bus service coverage area reflecting passenger attributes,” *Journal of the Eastern Asia Society for Transportation Studies*, Vol. 6, pp. 529 - 543, 2005.

[3] M. Ruiz, J. Maria, and J. Mateu, “Improving bus service levels and social equity through bus frequency modelling,” *Journal of Transport Geography*, Vol 58, pp. 220-233, 2017.

[4] M. S. Al-Mamun and N.E. Lownes, “A composite index of public transit accessibility,” *Journal of Public Transportation*, Vol. 14, No. 2, 2011.

[5] R.G. Mishalani, M.M. McCord, J.W. Edwards, “Passenger wait time perceptions at bus stops,” *Journal of Public Transportation*, Vol. 9, No. 2, 2006.

[6] Transportation Research Board, Transit Cooperative Research Program-TCRP, “Transit Capacity and Quality of Service Manual- TCQSM,” Report 165 - Chapter 4, 3rd ed. 2013.

[7] A.J. Mardan, “A geographical analysis of daily trips in Al-Nasiriyah city,” *Literature Journal - University of Basra* (74), 2015.

[8] S.M. Aboud and M.A. Mirza, “Transport regulation and relation to consumer rights - Study in the State Company for Private Transport - Iraq,” *Iraqi Journal of Market Research and Consumer Protection*, Vol. 5, No. 2, 2013.

[9] C. Morency, M. Trepanier, and M. Deners, “Walking to transit: An unexpected source of physical activity,” *Transport Policy Journal*, Vol. 18, pp. 800-806, 2011.

[10] K. Neatt and H. Millward, “Neighborhood walking densities: A multivariate analysis in Halifax, Canada,” *Journal of Transport Geography*, Vol 61, pp. 9-16, 2017.

[11] T.A. Khaleel, S.A. Salih, H.O. Ghaeb, “GIS based project information system for construction management,” *Engineering and Technology Journal*, Vol. 34, No. 7, pp.209-218, 2016.

[12] A. Fraszczyk and C. Mulley, “GIS as a tool for selection of sample areas in a travel behavior survey,” *Journal of Transport Geography*, Vol 34, pp. 233-242, 2014.

[13] A.G. Khalaf, “Determination the suiTable locations for drilling wells for irrigation purpose by using geographic information system (GIS),” *Engineering and Technology Journal*, Vol. 34, No. 3, pp.80-89, 2016.

[14] Directorate of Urban Land Transport – Urban Development Department, India, “TUMKER city bus service evaluation report,” 2013.

[15] New Zealand Transport agency, “Requirements for urban buses in New Zealand,” New Zealand’s common standard for urban bus quality,” 2014.